



TZ Medical
Sparked by your ideas

PRODUCT CATALOG

**Clinician-Driven Devices Designed for
Real Clinical Workflows**

**Innovative medical solutions that improve
patient care, safety, and efficiency.**

www.tzmedical.com





TZ Medical

Sparked by your ideas

TABLE OF CONTENTS

Sparked By Your Ideas	_____	3
The TZ Medical Story	_____	4
Radial Access	_____	6
Femoral Access	_____	9
Patient Positioning	_____	11
Interventional	_____	15
Defibrillation Electrodes	_____	17
Lab & Hospital Essentials	_____	19
Radiation Protection	_____	22
SoftGel Positioners	_____	28
Procedure Lighting	_____	30
Cardiac Monitors	_____	31
TZ Medical Monitoring Solutions	_____	33

TZ Medical Inc.

20497 SW Teton Ave, Suite A
Tualatin, OR 97062

Office: 800.944.0187 Fax: 503.639.0239
www.tzmedical.com



INNOVATION STARTS WITH YOU



SHARE YOUR IDEA



PARTNER WITH TZ



EARN ROYALTIES

SPARKED BY YOUR IDEAS

At TZ Medical, we take pride in our practice of partnering with physicians, nurses, and technologists to help bring new product ideas to market. With decades of practical experience in design, manufacturing, and engineering, we excel in transforming your innovative ideas into product realities. Our most reliable and valuable asset to improving healthcare is YOU.

FIND OUT MORE



800.944.0187



tzmedical.com



TZ Medical
Sparked by your ideas

THE TZ MEDICAL STORY

When TZ Medical founder, Tom Tribou, sat planning his new company in a Portland coffee shop in 1990, he made two bedrock decisions. The first was that TZ Medical would turn the paradigm of medical equipment manufacturing on its head by taking the time to listen to medical professionals on the front lines, and find out what they needed, before huddling with its own engineers. The second decision was that pricing should be at the value level, to ensure that these bright ideas would make their way into the hands of critical-care medical professionals faster.

Over the years these ideas have served the company well. What was once a small collection of critical-care devices has grown into a whole family of medical products, sparked by your ideas. With products sold across the nation and all over the world, TZ Medical has built a solid reputation for itself on the first two decisions laid out in the company's infancy.

Today, the TZ Medical team is recognized as a group that creates products based on input from professionals in some of the finest medical facilities throughout the world. These innovative health professionals have often helped supply the missing piece of a puzzle, revealed the essence of a problem, or posed the perfect "what if" question in order to help solve a dilemma, and facilitate practical solutions.

Between our dedication to listening, and our firm belief in affordable pricing, it's no wonder that TZ Medical has been, and will continue to be, a lasting leader in the medical device manufacturing world.



OUR MISSION STATEMENT

Our mission is to design, manufacture, and deliver products that meet and exceed the needs and expectations of each customer. We will sustain our vision and mission by constantly seeking renewal via continuous education and learning, and the application of new technologies and best business practices. We will do business as model individuals and corporate citizens in our local and international communities. We will "play to win", acting with absolute honesty, integrity, and fairness in the way we conduct our business and the way we live our lives.



TZ Medical
Sparked by your ideas



CATH, IR & EP LABS!

**WE NEED YOUR
EXPIRED PRODUCT**

**ALL PRODUCT WILL BE USED
FOR CLINICAL EDUCATION**

**DON'T THROW IT AWAY -
DONATE IT!**



CONTACT US

Reach out to your local rep or...

☎ 800.944.0187

✉ info@tzmedical.com

RADIAL ACCESS PRODUCTS

RADIAL RUNWAY



RADIAL ACCESS WRIST POSITIONER

The Radial Runway provides a radiolucent platform that keeps the patient's wrist in a deflected position for ideal radial access. Disposable straps allow the wrist to be positioned in multiple neutral or extended angles, optimizing patient comfort and physician preference. The foam pad and straps remain with the patient post-procedure, acting as an immobilizer for the patient's wrist during recovery.

- Can be used for radial access on either wrist
- Wrists may be positioned at multiple angles
- Disposable straps, foam pad & brace
- Base can be sterilized & reused
- Adjustable straps fit any size patient
- Pad with brace remains with the patient for recovery



Item Number	Description	UOM
RRU-0008	Radial Runway - Reusable Base	1 Each
RRU-0009	Disposable Top Pad, Straps, and Brace	Box of 10

RUNWAY PRO



RADIAL ACCESS WRIST POSITIONER

The Runway Pro is TZ Medical's next-generation wrist positioning system, engineered to eliminate unwanted arm movement during radial access procedures. Its newly designed suction-mounted base securely attaches to the Radial Board or any flat procedural surface, creating a rock-solid foundation for consistent, reliable wrist positioning.

- Locks the arm and wrist in place to prevent movement during access, intervention, and recovery
- Powerful suction base adheres securely to the Radial Board or any flat surface
- Supports left or right wrist with multiple neutral and extended positioning angles
- Disposable foam pad and adjustable straps fit all patients and remain post-procedure
- Improves clinician confidence, workflow, and patient comfort



Item Number	Description	UOM
RRU2-1005	Runway Pro Base	1 Each
RRU2-1010	Runway Pro Top Pad & Straps	Box of 10

RADIAL ACCESS PRODUCTS

LEVELUP RADIAL BOARD

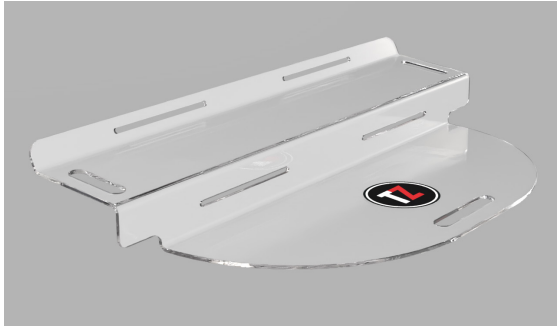

ARM ELEVATING RADIAL BOARD

The LevelUp Radial Board is designed to elevate the patient's arm so it aligns perfectly with the top of the table mattress, ensuring optimal positioning and comfort during radial catheterization procedures. Its low-profile design easily slides under the table mattress for quick setup and stability. The LevelUp Radial Board can be used on either the left or right side of the table, making it an essential accessory for any cath lab.

- Extremely durable polycarbonate construction
- Easy to slide and reposition under the table mattress
- Can be used on the right or left side of the table for radial arterial procedures
- Improves patient comfort by keeping the arm level with the table mattress
- Improves physician posture when accessing the radial sheath, reducing stress and fatigue

Item Number	Description	UOM
LVL-0001	LevelUp Radial Board	1 Each

TOTAL ACCESS RADIAL BOARD



LARGE CARBON FIBER RADIAL BOARD

The Total Access Radial Board is a lightweight carbon fiber board specifically shaped for convenient radial access in conjunction with medical imaging and to increase patient comfort. It has a large landing zone for equipment and can be used for right- or left-side access.

- Can be used on either the right or left side for radial access
- Large landing area for equipment
- Lightweight carbon fiber construction
- Invisible under fluoroscopy
- Can be used for all diagnostic & interventional imaging procedures



Item Number	Description	UOM
CZ-400	Total Access Radial Board	1 Each



SECURE RADIAL BOARD



CARBON FIBER RADIAL BOARD WITH STRAPS

The TZ Medical Secure Radial Board is specifically designed to secure and position the patient's right or left arm during vascular procedures. The arm board and straps prevent unwanted movement, ensuring a stable and consistent image for the physician when performing vascular access.

- Can be used on either the right or left side for radial access
- Straps reduce patient movement
- Large landing area for equipment
- Lightweight carbon fiber construction
- Invisible under fluoroscopy
- Can be used for all diagnostic & interventional imaging procedures



Item Number	Description	UOM
CZ-400-TVA	Secure Radial Board	1 Each
TVA-MC-2	Disposable Straps - One 18" Strap, Two 24" Straps	Each (3 Straps)

COBRA BOARD



LEFT RADIAL ARM POSITIONER

The Cobra Board is a buttress device that can prevent arm drift during left radial artery procedures. Its flexible 12-inch gooseneck design accommodates a wide range of anatomical variations. Made from high-tensile material, the gooseneck ensures that the instrumented arm remains stable and does not drift away from the operator during catheterization procedures. The carbon fiber base plate fits securely between the procedural table and the mattress, while the cuff is positioned behind the patient's tricep to provide optimal comfort and enhance ergonomic conditions for the operator.

- High tensile 12" gooseneck can be adjusted to desired position
- Carbon fiber base plate
- Prevents left arm movement during procedures
- Detachable cuffs are disposable post-procedure & are available in two sizes
- Cuffs are designed with soft ergonomic padding to enhance patient comfort

Item Number	Description	UOM
CBR-0045-S	Cobra Board Kit - Cobra Board, Box of Small Cuffs, Box of Large Cuffs	1 Kit
CBR-0050-S	Cobra Board Cuffs - 2 Boxes of Small Cuffs**	1 Kit
CBR-0055-S	Cobra Board Cuffs - 2 Boxes of Large Cuffs**	1 Kit
CBR-0065-S	Cuff Replacement Kit - 1 Box of Small Cuffs, 1 Box of Large Cuffs**	1 Kit

****Cobra Board Cuffs are packaged in boxes of 4 cuffs**

FEMORAL ACCESS PRODUCTS

NEPTUNE

TOPICAL HEMOSTASIS PADS

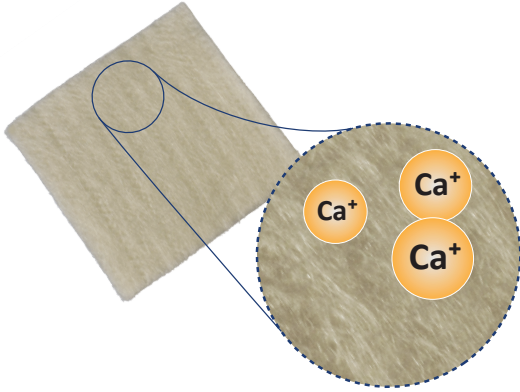

The TZ Medical Neptune Pad is a natural product derived from sustainably harvested seaweed that utilizes calcium ions to facilitate hemostasis. These ions are activated by the introduction of blood to the Neptune Pad and help to speed up clot formation at the puncture site naturally.

Neptune has no known contraindications and is safe to use on all patients. The texture of the pad eliminates sliding, sliming, and sticking to gloves, and because the entire pad is the active ingredient, there is no "right-side-up."

- Speeds up hemostasis
- Extra-large 2" x 2" surface area
- Naturally derived from seaweed
- Ad-Skin Patch Transparent Film Dressing included
- Latex-free & contains no animal products
- Texture helps prevent sliding or sticking
- Cost-effective

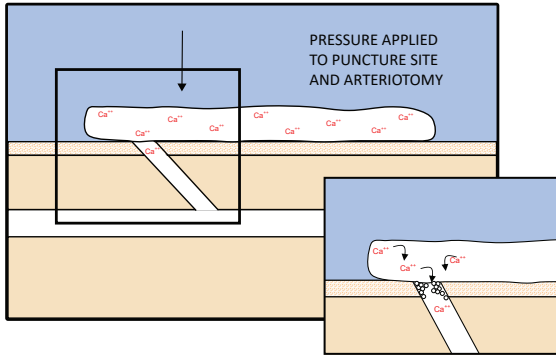

Item Number	Description	UOM
8870-01	Standard 2"x2" Neptune Pad	Box of 10
8870-03	Neptune Plus with Polymer Backing	Box of 10
8870-04	Standard 1"x2" E-Neptune Pad	Box of 10
8870-07	SilverStat - Antimicrobial Pad with Silver	Box of 10

NEPTUNE



Standard 2" x 2" Neptune Pad with an all-natural active ingredient woven into the material.

NEPTUNE PLUS

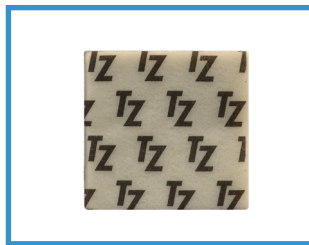

Premium 2" x 2" Neptune Pad with an added transparent protective polymer backing on one side.

E-NEPTUNE



Standard 1" x 2" Neptune Pad that provides all of the same benefits as the Standard Neptune pad at half the size.

SILVERSTAT



Slim 2" x 2" Neptune Pad with an additional silver nitrate element that adds antimicrobial support to help prevent bacterial infections.



EZ HOLD

MANUAL COMPRESSION DEVICE



The EZ Hold is a manual-assist compression device developed to aid the clinician in manual femoral pressure.

The device was designed and patented by an RN who sought to reduce hand fatigue and direct contact with bodily fluids. The ergonomic design of the EZ Hold permits the clinician to hold pressure comfortably with one hand while palpating the pulse with the other.

The EZ Hold is best used in conjunction with our line of Standard Discs and Neptune Discs. These come in two styles and have the advantage of having a Neptune pad built into the disc, which speeds up hemostasis and reduces holding times.

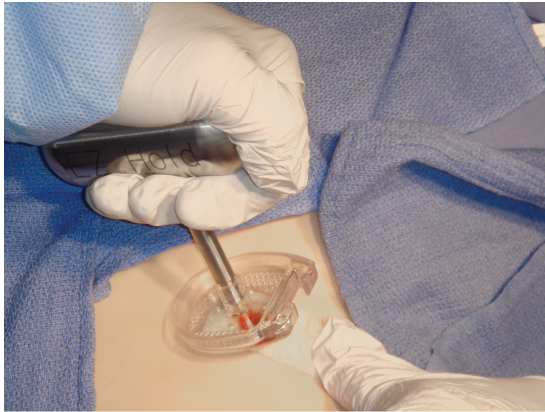

- Reduces hand fatigue
- Ergonomic design
- Cuts down on direct contact with bodily fluids
- Can be held comfortably with one hand
- Fits a wide variety of discs
- Neptune Discs speed up hemostasis

Item Number	Description	UOM
8260-20	2 lb. EZ Hold	1 Each

COMPRESSION DISCS

MANUAL COMPRESSION DISCS

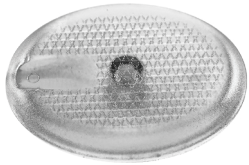

Oval Universal



Round Universal



Round Omega

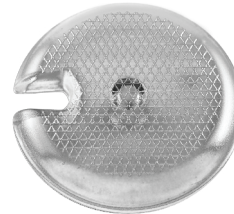

Large Round Omega



Oval Omega



Neptune Round Universal



Neptune Oval Universal

Item Number	Description	UOM
8880-01	Oval Universal Disc	Box of 50
8880-02	Round Universal Disc	Box of 50
8880-03	Oval Universal Disc with Omega Opening	Box of 50
8880-04	Round Universal Disc with Omega Opening	Box of 50
8880-06	Large Round Universal Disc with Omega Opening	Box of 50
8880-07	Oval Universal Disc with Neptune	Box of 10
8880-08	Round Universal Disc with Neptune	Box of 10

PATIENT POSITIONING PRODUCTS

PANNUS RETENTION SYSTEM - 02

TWO PADS AND ONE STRAP



The TZ Medical Pannus Retention System (PRS) is a versatile hook-and-loop pad and strap solution designed to safely and efficiently manage excess tissue in high BMI patients. Quick and easy to apply, the PRS not only secures tissue but also serves as a reliable patient positioning tool for a range of procedures, including femoral access for heart catheterizations and TAVRs, left arm deflection for radial access, and breast deflection for pacer or ICD implants. By combining safety, efficiency, and adaptability, the PRS helps clinicians streamline workflow while maintaining optimal patient positioning, with the safety of the patient's skin integrity as a priority.

- Hypoallergenic, latex & residue-free
- Adhesive pads are designed to reduce damage to the skin
- Ideal for groin access, left-side radial access, & more!
- Completely adjustable system - will fit any sized patient
- Can be applied in less than one minute
- Easy to reposition after application



Item Number	Description	UOM
CZ-PRS-02	Pannus Retention System - Two Pads, One Strap, Non-Sterile	Box of 10

PANNUS RETENTION SYSTEM - 04

FOUR PADS AND TWO STRAPS



The TZ Medical Pannus Retention System (PRS-04) provides a safe and effective method for positioning and retracting excess pannicular tissue during groin access procedures in high BMI patients. Designed for quick application, the PRS-04 can be securely placed in under one minute, allowing clinicians to easily position patients for a wide range of procedural needs.

This system includes four adhesive pads and two adjustable medical-grade hook-and-loop straps, which can be repositioned at any time during use for optimal patient comfort and accessibility. The proprietary, residue-free adhesive minimizes the risk of skin tears and degradation often associated with traditional tape or competing products, ensuring both safety and ease of use in clinical settings.

- Ideal for bilateral access & Trans Aortic Valve Replacements (TAVR)
- Hypoallergenic, latex & residue-free
- Adhesive pads are designed to reduce damage to the skin
- Completely adjustable system - will fit any sized patient
- Can be applied in less than one minute
- Easy to reposition after application
- Sterile & designed for surgical procedures

Item Number	Description	UOM
CZ-PRS-04	Pannus Retention System - Four Pads, Two Straps, Sterile	Box of 10



CRANIAL IMMOBILIZATION SYSTEM HEAD STABILIZATION DEVICE



The Cranial Immobilization System (PRS-03) is a safe and effective solution for immobilizing the patient's head during imaging and various other surgical procedures. Designed with micro hook-and-loop technology, this unique system is completely adjustable to ensure optimal support and comfort for your patients.

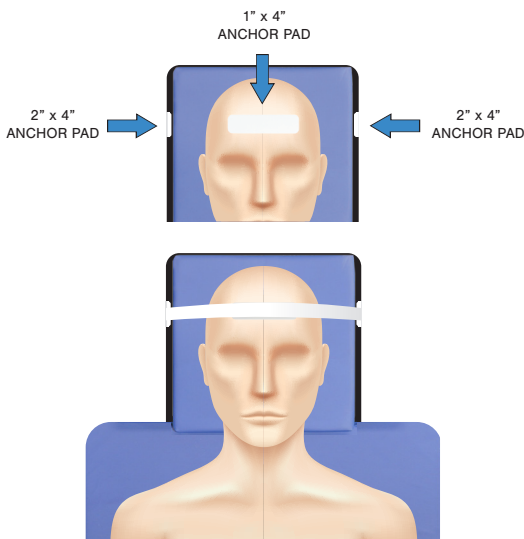

- Immobilizes the patient's head in a safe & effective manner
- Hypo-allergenic, latex-free & residue-free
- Completely adjustable system - easy to apply & reposition if needed
- Prolongs equipment life-span & increases regulatory compliance by avoiding tape & tape residue
- Can be used in various procedures such as Cataract Surgery, Neurointerventional Radiology, MRI/CT scans, & more!

Item Number	Description	UOM
CZ-PRS-03	Cranial Immobilization System	Box of 10

BREAST DEFLECTION ALTERNATIVE APPLICATION

Simple, effective breast deflection for pacemaker and ICD implantation; PRS-03 securely and safely deflects breast tissue away from the implant location, ensuring optimal accessibility. The hypoallergenic adhesive used in the system is gentle on sensitive tissue and can be removed easily from both the patient and the equipment without leaving any sticky residue.

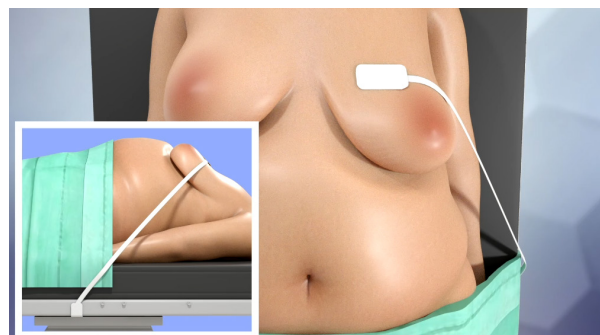
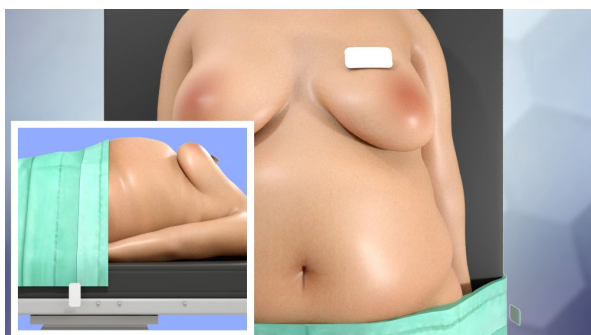

PATIENT POSITIONING PRODUCTS

COMFORT CRADLES

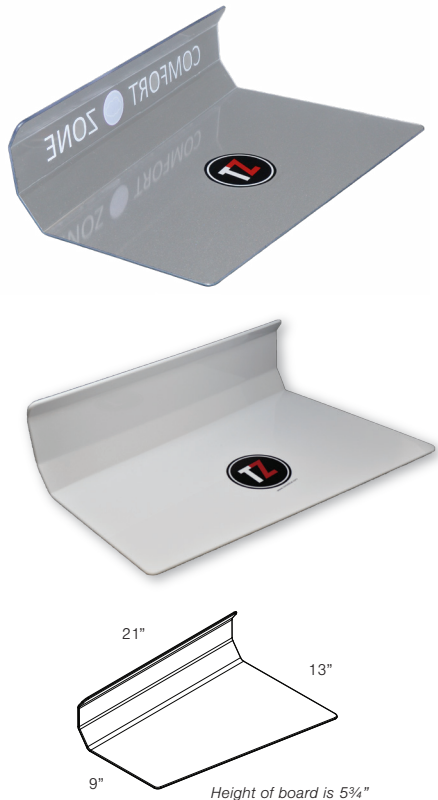

PATIENT ARMBOARDS

The TZ Medical Comfort Cradle is a versatile product that aids both the patient and the operator during procedures. The cradle's extended width improves comfort, making long procedures more tolerable for the patient. It is available in a clear polycarbonate material or a white polypropylene material, both providing durability and comfort. The dimensions of the Comfort Cradle provide superior support during vascular procedures when compared with smaller, less robust arm boards.

- Patient is more accessible to the physician
- Extra wide dimensions for added comfort
- Reduces secondary & scatter radiation when using the Comfort Shield drape
- Options of either durable polycarbonate or polypropylene construction



Compatible with the Comfort Shield

Item Number	Description	UOM
CZ-100	Comfort Cradle Kit	Set of 2
CZ-001	Comfort Cradle Replacement Board	1 Each
CZ-100-PP	Polypropylene Comfort Cradle	Set of 2
CZ-001-PP	Polypropylene Comfort Cradle Replacement Board	1 Each

PATIENT IMMOBILIZER



REUSABLE IMMOBILIZATION DEVICE

The Patient Immobilizer secures the patient during imaging procedures to limit excess movement, thereby eliminating motion artifact. This greatly reduces the need for repeat subtraction runs, which in turn decreases patient and staff radiation exposure. The patient's wrists can be safely attached to the leg wrap using the quick snap and rapid adjustment webbing, which can be quickly undone once the procedure is complete. For additional safety, a second wrap may also be secured around the patient's chest.

- Improves safety for the patient & staff during imaging procedures
- Eliminates motion artifact caused by patient movement
- Cuts down on the need for repeat subtraction runs
- Quick snap & rapid adjustment webbing for fast immobilization of the patient
- Patient may be effectively secured during procedures where conscious sedation is used

Item Number	Description	UOM
CZ-106	Patient Immobilizer - Includes 1 set of CZ-008	1 Kit
CZ-107	GE Patient Immobilizer - Includes 1 set of CZ-008	1 Kit
CZ-008	Disposable Wrist Wraps	1 Each
CZ-012	XXL Extender	1 Each



COMFORT HALO

ANESTHESIA DRAPE POSITIONER



The TZ Medical Comfort Halo is designed to enhance safety and comfort for patients undergoing conscious sedation. The polycarbonate base is compatible with all bed types, allowing it to easily slide underneath the imaging table mattress pad. The steel and vinyl tubing can be manipulated into a multitude of different draping positions, keeping the drape out of the patient's face and allowing complete visualization of the patient at all times.

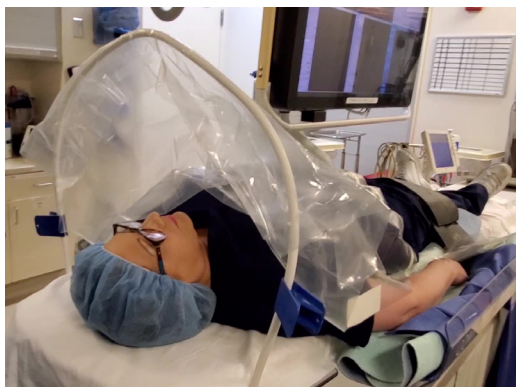

- Increases patient comfort by keeping anesthesia drape off of patient's face during conscious sedation
- Ideal for all departments using radiographic imaging & sterile technique
- Offers an unobstructed view of patient during procedure
- The flexible design may be molded to the desired shape or height
- Compatible with any bed type, no arm rails necessary



Item Number	Description	UOM
CZ-009	Comfort Halo	1 Each

SIDEWINDER BOARD

ANESTHESIA DRAPE POSITIONER



The TZ Medical Sidewinder Board is a simple solution that improves patient safety and comfort by effectively positioning the anesthesia drape away from the patient's face while undergoing conscious sedation. Designed with a sturdy carbon fiber base and a flexible gooseneck, the Sidewinder Board slides underneath the table mattress on either side of the patient and is easily adjustable during any procedure. The malleable steel and vinyl gooseneck can be molded into unlimited draping positions, enhancing visualization and patient satisfaction.



- Improves patient comfort
- Enhances visualization of the patient during procedures
- Flexible gooseneck can be molded to any desired shape or height
- Carbon fiber base can be positioned on either side of the patient
- Compatible with any bed type, no arm rail necessary



Item Number	Description	UOM
CZ-009-HH	Sidewinder Board	1 Each

INTERVENTIONAL PRODUCTS

ACCUFLATE

INFLATION DEVICE



The TZ Medical AccuFlate is a 20ml disposable device designed to accurately control and monitor pressure during inflation and deflation of dilation balloon catheters. Our patented technology allows the AccuFlate to generate pressure up to 30 atm or 40 atm with accuracy of ± 1 atm.

- Precision manometer with 30 atm & 40 atm maximum pressure options
- A patented self-locking mechanism for easy one-handed locking control
- Ergonomic handle with gradual & rapid pressure release
- Optional, male rotating Luer Lock, 3-way stopcock with "ON" or "OFF" tap handle
- PTCA Accessory Kit available



Item Number	Description	UOM
IDD-0001	30 atm Balloon Inflation Device	Box of 5
IDD-0040	40 atm Balloon Inflation Device	Box of 5
IDD-0010	AccuFlate with PTCA Kit	Box of 5
IDD-0020	PTCA Accessory Kit with Tuohy-Borst Valve, Guidewire Insertion Tool, & Torque Device	1 Each

PUSH-CLICK

Y-CONNECTOR KIT

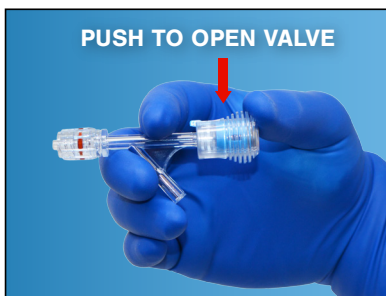

The TZ Medical Push-Click Y Connector is designed to provide rapid, single-handed valve manipulation with a simple push-and-click action. When the mechanism is compressed, the release lever holds the valve in an "open" position, allowing for free movement of wires and catheters. When wire/catheter manipulation is no longer needed, the valve can then be closed by disengaging the release lever. The Push-Click Y Connector Kit includes a Wire Introducer and a Torque Device.

- Simple one-handed operation
- Rapid & robust valve closure with audible actuation
- 7.9F inner diameter

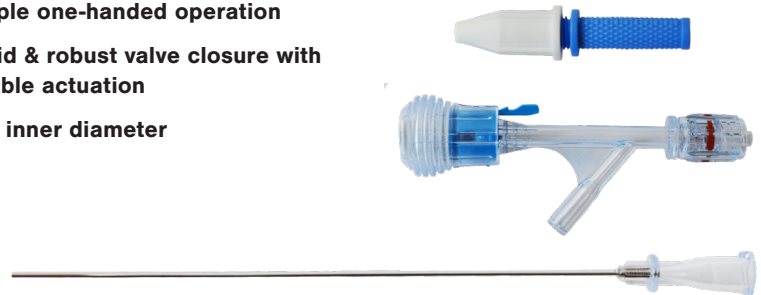

Item Number	Description	UOM
IDD-0030	Push-Click Y Connector Kit with Wire Introducer & Torque Device	Box of 5



PEDAL BAND



PEDAL ACCESS COMPRESSION DEVICE

The TZ Medical Pedal Band is a versatile mechanical compression device designed to deliver controlled, consistent pressure after vascular access procedures. Featuring an intuitive turn-dial mechanism and a soft silicone compression pad, the Pedal Band allows clinicians to fine-tune the amount of pressure applied, helping to support hemostasis while maintaining patient comfort.

- Versatile design allows the device to be positioned in multiple orientations for pedal and tibial vascular access
- Two adjustable straps to accommodate a variety of anatomical locations
- Completely transparent viewing window for optimal visualization
- Mechanical turn-dial and silicone pad enable fine-tuning of pressure
- No syringe required

Engineered for multi-application use, the Pedal Band adapts seamlessly to a variety of access points—including pedal and tibial vascular sites. Its flexible design includes two adjustable straps, enabling the device to be positioned in multiple orientations to accommodate different anatomical locations and procedural needs.

Item Number	Description	UOM
PHD-0015	Pedal Hemostasis Device	Box of 10

SHOOT 'N SEE

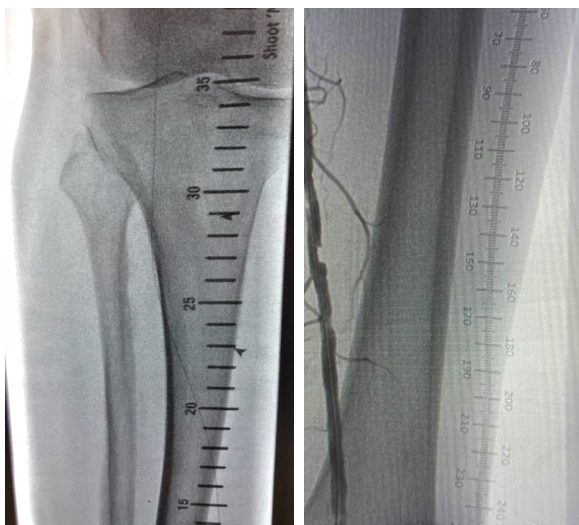
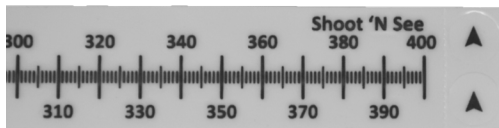
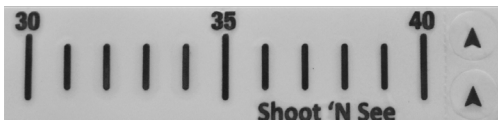

RADIOPAQUE TAPE

The TZ Medical Shoot 'N See is a flexible medical-grade tape for use during any vascular procedure involving radiography or fluoroscopy. Applied to the skin or drape before the procedure, the radiopaque markings are visible both to the naked eye and under fluoroscopy, which allows for quick cross-referencing between the inside and outside of a patient's body.

- Fully visible with or without fluoroscopy
- Arrow indicators to show the precise location of the lesion(s)
- Allows for quick cross-referencing between the inside/outside of the patient's body
- Packaged sterile & measures up to 40 cm or 400 mm
- Great for vascular procedures

Item Number	Description	UOM
RCM-0005-10	Shoot 'N See 40 cm Tape	Box of 10
RCM-0005-30	Shoot 'N See 40 cm Tape	Box of 30
RCM-0005-50	Shoot 'N See 40 cm Tape	Box of 50
RCM-0020-10	MM Shoot 'N See 400 mm Tape	Box of 10
RCM-0020-30	MM Shoot 'N See 400 mm Tape	Box of 30
RCM-0020-50	MM Shoot 'N See 400 mm Tape	Box of 50

ELECTRODES & GROUNDING PADS

DEFIBRILLATION ELECTRODES

ADULT, PEDIATRIC, AND STERILE ELECTRODES



Our multi-function electrodes are designed for EP and Cath Labs, Cardiac Surgery, Critical-Care Areas and other related departments. They are designed for defibrillation, synchronized cardioversion, external pacing and ECG monitoring. Compatible with biphasic defibrillators, our electrodes offer direct connections to a variety of defibrillators, such as Zoll® and Medtronic® QUIK-COMBO™. We also offer adapters, allowing multiple brands of defibrillators to use the same electrodes.

- Lead wire lengths available in 60" & 120" for maximum convenience & utility
- Hydrogel maintains excellent adhesion to the patient's skin
- Radiotransparent & radiotranslucent options available

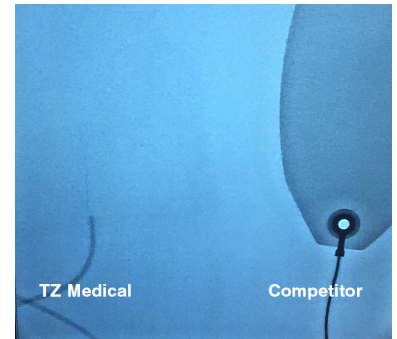

LIFEPAK® M1 Connector



Universal T1 Connector



Zoll® Z1 Connector



Description	Size	LifePak® ¹	Universal ²	Zoll® ³
Adult Radiotranslucent Pads, Leads Out	A	P-111-M1	P-111-T1	P-111-Z1
Adult Radiotransparent Pads and Leadwires	A	P-211-M1	P-211-T1	P-211-Z1
Adult Radiotransparent Pads and Leadwires, Leads Out	A	P-311-M1		P-311-Z1
Adult Radiotranslucent, Sterile	A	P-121-T1 PAD 1111 Adapter*	P-121-T1	P-121-T1 PAD 101PD Adapter*
Adult Radiotransparent, Large Posterior Pad	A/B	P-214-M1	P-214-T1	P-214-Z1
Adult Radiotransparent Pads and Leadwires, Large Posterior Pad, Sterile	A/B	P-224-T1 PAD 1111 Adapter*	P-224-T1	P-224-Z1
Pediatric Radiotranslucent Pads, Sterile	C	P-122-T1 PAD 1111 Adapter*	P-122-T1	P-122-T1 PAD 101PD Adapter*
Pediatric Radiotransparent Pads and Leadwires	C	P-212-M1		P-212-Z1

Lead Wire Length

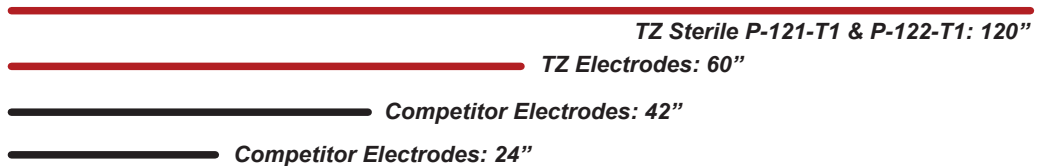

Pediatric Use: Pediatric patients whose weight is less than 25Kg (55 lbs).

Pad Dimensions:

- A = 6"x4.25"
- B = 6"x9"
- C = 4.25"x2.876"

*Adapters are reusable

- 1 – M1 LifePak models are comparable to LifePak Physio-Control QUIK-COMBO™ electrodes.
- 2 – T1 Anderson models allow for multiple brand of defibrillators to use the same electrodes. (adapter needed)
- 3 – Z1 Zoll Models are comparable to Zoll® multifunction electrodes.

GROUNDING PADS

GROUNDING ELECTRODES



TZ Medical's Grounding Pads are indifferent skin contact electrodes designed for energy return of radiofrequency energy in surgical and electrophysiology procedures. The soft foam structure and sticky hydrogel provide optimal adhesion that comfortably conforms to the patient's body while maintaining a large surface area to focus radiofrequency energy at the application site.

- Utilized for safe return of electrosurgical energy from the patient
- 9.8 foot Lead Wire
- Designed with adhesive hydrogel for secure patient application
- Compatible with most generators on the market
- Comfortable foam structure conforms to the patient's body

Item Number	Description	UOM
P-411-V1	Disposable Grounding Pad Electrodes	Box of 50

For more information on our electrode options or available adapters, please visit tzmedical.com or contact us at info@tzmedical.com.

LAB & HOSPITAL ESSENTIALS

PRO11 HEADSET SYSTEM



WIRELESS COMMUNICATION SYSTEM

The TZ Medical Pro11 Headset System enables teams to talk hands-free in the Cath Lab, EP Lab and adjacent rooms - no raised voices or straining to hear, just clear, calm communication between every member of the team, reducing stress and creating a better working environment. The system has full connectivity with external broadcast and audiovisual streaming facilities, enabling the physician to participate real-time in remote broadcasts and seminars. Using high-quality DECT frequencies, multiple systems can be used in the same premises without interference.

Item Number	Description	UOM
TZ-Q-P11BS	Pro11 Base Station	1 Each
TZ-Q-P11CH	Pro11 Charger	1 Each
TZ-Q-P11HS	Pro11 Headset (battery and headband included)	1 Each

Item Number	Description	UOM
TZ-Q-P11BAT	Battery for Headset	1 Each
TZ-Q-P11HB	Headband for Headset	1 Each
TZ-Q-P11NB	Neckband for Headset	1 Each
TZ-Q-RH7HC	Hygiene Covers	Box of 100
TZ-Q-RH7EC	Ear Cushions	Box of 10
TZ-Q-P10SHELF	Battery Charger Shelf	1 Each

ANTI-FATIGUE MATS



ERGONOMIC PROCEDURE ROOM MATS

- Unmatched ergonomic comfort & support
- Constructed with eco-friendly Bio-Foam®
- Durable, stain-resistant surface with brushed texture design
- Certified by the National Floor Safety Institute for superior high-traction bottom surface
- Beveled edges for added safety

36"x114"

36"x60"

20"x32"

20"x48"

24"x36"

20"x72"

Item Number	Description	UOM
NLEP-20X32	Durable 3/4" Thick Bio-Foam® Size 20X32, Black	1 Each
NLEP-20X48	Durable 3/4" Thick Bio-Foam® Size 20X48, Black	1 Each
NLEP-20X72	Durable 3/4" Thick Bio-Foam® Size 20X72, Black	1 Each
NLEP-24X36	Durable 3/4" Thick Bio-Foam® Size 24X36, Black	1 Each
NLEP-36X60	Durable 3/4" Thick Bio-Foam® Size 36X60, Black	1 Each
NLEP-36X114	Durable 3/4" Thick Bio-Foam® Size 36X114, Black	1 Each



MATTRESS PADS

CATH LAB, ANGIO, & X-RAY MATTRESSES



Designed for shorter procedures or short stay procedural/exam tables.

Secondary Fluid Barrier

■ Inserted between the foam and cover, this barrier provides unique protection; if the outer layer is compromised, the foam is protected

Vynmed™ Healthcare Vinyl Cover

- Anti-bacterial, anti-fungal, water & stain resistant
- Non-allergenic, non-irritating
- Phthalate free, latex free & odor resistant

STANDARD X-RAY/ANGIO PADS

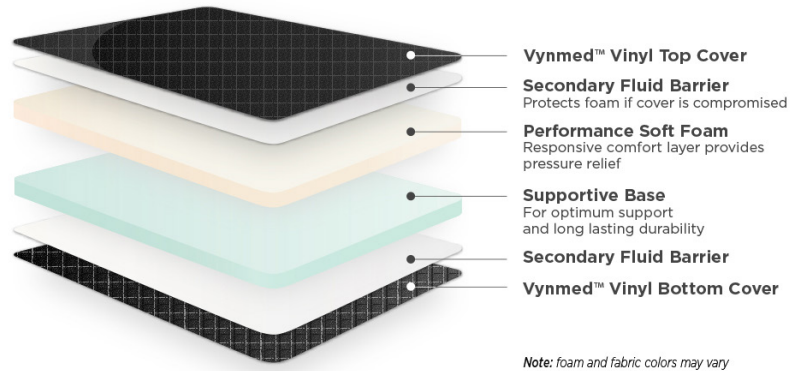

Note: foam and fabric colors may vary

ULTRA COMFORT X-RAY/ANGIO PADS

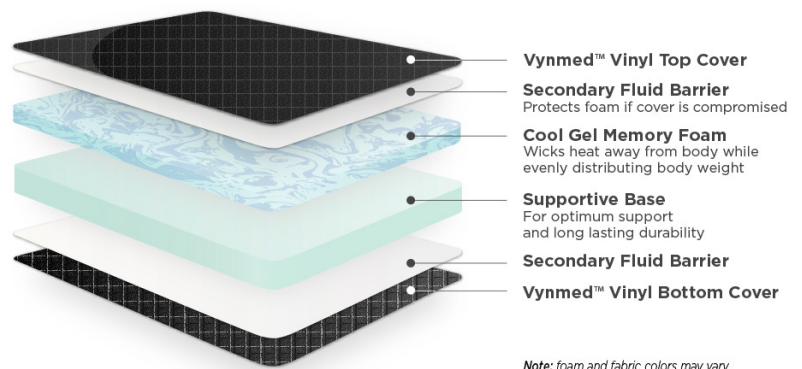

Note: foam and fabric colors may vary

INDUSTRY-LEADING COMFORT

Our pressure-mapped custom foam layering ensures an optimal level of comfort for every patient.

DURABILITY YOU CAN TRUST

Advanced stability layers provide long-lasting comfort without sagging, ensuring consistent, hard-working performance every time it's used.

EASILY CLEANED REMOVABLE COVERS

Our expertly made covers provide a safe, comfortable, and durable solution for the healthcare industry.

LAB & HOSPITAL ESSENTIALS

STAINLESS STEEL TABLES



INSTRUMENT TABLES

TZ Medical now offers a line of stainless steel instrument tables. Each lightweight stainless steel table has heavy-duty swivel casters, a lower shelf, fully welded legs, and 16-gauge steel. Available in three lengths, TZ tables provide a stable, easy-to-clean surface for all procedures throughout the hospital.

- 16-gauge stainless steel
- Closed hems for simple cleaning
- Convenient lower shelf for storage
- Comes in three lengths: 48", 60", & 72"
- Tables are delivered fully assembled
- Made in the USA

Item Number	Description	UOM
SSIT-48	Instrument Table - 48"L x 24"W x 34"H	1 Each
SSIT-60	Instrument Table - 60"L x 24"W x 34"H	1 Each
SSIT-72	Instrument Table - 72"L x 24"W x 34"H	1 Each



48" TABLES



60" TABLES



72" TABLES

CONTRAST DRIP TRAY

HIGH-QUALITY DRIP TRAY REPLACEMENT

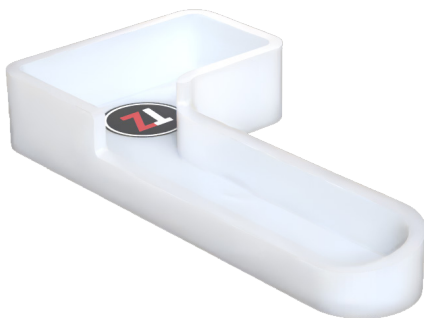

The TZ Medical Contrast Drip Tray is a high-quality replacement designed for the ACIST CVi Contrast Delivery System® (OEM part no. 201547-001). Engineered for durability, it offers a long-lasting alternative to the OEM tray, which is prone to breaking.

Item Number	Description	UOM
CDT-0001	Contrast Drip Tray	1 Each



RADIATION PROTECTION

URPRO

BDR-1002



BDR-1015



OLD PANELS

NEW PANELS

REPLACEMENT TABLE PANELS

The TZ Medical URPro is a universal system that directly replaces your current MAVIG™ shields with high-quality, long-lasting radiation protection panels. The new URPro Adapter panels are uniquely designed to fit over any MAVIG™ frame system using an adjustable strap that quickly secures around the frame, making placement or removal quick and simple.

- Attenuates 98% of secondary & scatter radiation at 80 kVp
- Lead equivalence of 0.50 mm
- Directly compatible with current MAVIG™ bedside drape framing systems
- Simple installation process
- Fabric binding & structured frame reduce long-term fraying & deterioration

Item Number	Description	UOM
BDR-1002	URPro 35" Replacement Panel	1 Panel
BDR-1002-5	URPro 35" Replacement Set	5 Panels
BDR-1015	URPro 35" Adapter Replacement Panel	1 Panel
BDR-1015-5	URPro 35" Adapter Replacement Set	5 Panels
BDR-1020	URPro 30" Replacement Panel	1 Panel
BDR-1020-5	URPro 30" Replacement Set	5 Panels
BDR-1025	URPro 30" Adapter Replacement Panel	1 Panel
BDR-1025-5	URPro 30" Adapter Replacement Set	5 Panels

URPRO UPPER SHIELDS

REPLACEMENT UPPER SHIELD PANELS



Enhance your radiation protection setup with TZ Medical's URPro Upper Shield Replacement Panels, engineered for full compatibility with the MAVIG™UT69 framing system. Crafted from high-quality, long-lasting materials, each panel is built to withstand daily clinical use while maintaining exceptional protective performance.

- Attenuates 98% of secondary & scatter radiation at 80 kVp
- Lead equivalence of 0.50 mm
- Directly compatible with current MAVIG™ UT69 shielding systems
- High-quality and long-lasting
- Available in height sizes small (17cm) and large (25cm)

Item Number	Description	UOM
BDR-1053	URPro Upper Shield Panels, Small	4 Panels
BDR-1052	URPro Upper Shield Panels, Large	4 Panels

RADIATION PROTECTION

URPRO OVERHEAD

REPLACEMENT OVERHEAD PANELS



The TZ Medical URPro Overhead is a universal shield that directly replaces your current MAVIG™ overhead shielding with high-quality, long-lasting radiation protection. The URPro Overhead shield is well-structured with fabric binding around the edges, and flexible overlapping strips with a lead equivalency of 0.50 mm.

- Attenuates 98% of secondary & scatter radiation at 80 kVp
- Lead equivalence of 0.50 mm
- Directly compatible with current MAVIG™ overhead shielding systems
- Available in 40 cm and 50 cm widths
- Simple installation process

Item Number	Description	UOM
BDR-1030	40cm Overhead URPro Panel Assembly	1 Each
BDR-1035	50cm Overhead URPro Panel Assembly	1 Each

COMFORT SHIELD

MOBILE RADIATION DRAPE

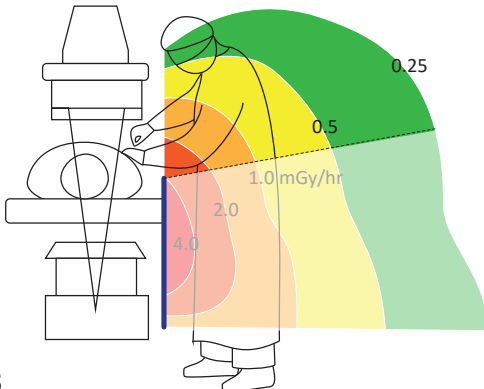

The Comfort Shield is a leaded shield accessory that supplements the Comfort Cradle arm board. The shield measures 23" x 30", offering a large area of radiation protection to medical staff during procedures involving fluoroscopy.

The Comfort Shield is designed to fit easily over the TZ Medical Comfort Cradle arm board and attenuates nearly 98% of secondary and scatter radiation while remaining unobtrusive to the medical staff. It is easy to sanitize, and comes with a hanger for easy storage.

- Attenuates 97.9% of secondary & scatter radiation at 80 kVp & has 0.5mm lead equivalence
- Low-profile design of Comfort Cradle maintained when shield is in use
- Easy to slip on & off the Comfort Cradle arm board
- Made of durable, flexible material that is easy to sanitize
- Comes with hanger for easy storage



Item Number	Description	UOM
CZ-105	Comfort Shield - Mobile Radiation Drape	1 Each



FLIPPER

RADIATION PROTECTION SHIELD

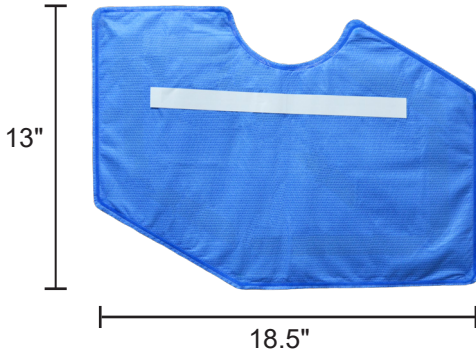

The Flipper is a versatile radiation shield designed to keep physicians safe without getting in the way of the procedure. The Flipper's 18.5"x13" design allows for use on either the right or left side for femoral groin access or subclavian access. Convenient adhesive strips on either side of the shield allow it to be secured in place to avoid slipping.

Lead-free, and attenuating up to 83% of radiation at 90 kVp, the Flipper is ideal for Interventional Radiology, Cardiac Cath Labs, Electrophysiology and more.

- Attenuates up to 83% of radiation at 90 kVp
- Reduces scatter radiation exposure to operators & staff
- Can be used for femoral groin access or subclavian access
- Adhesive on both sides to prevent slipping
- Lead equivalence 0.125mm
- Perfect for Interventional Radiology, Cardiac Cath, Electrophysiology & more
- Flipper is single-use & sterile



Item Number	Description	UOM
CZ-007	Flipper Radiation Shield	Box of 15

PERIPHERAL FLIPPER

RADIATION PROTECTION SHIELD

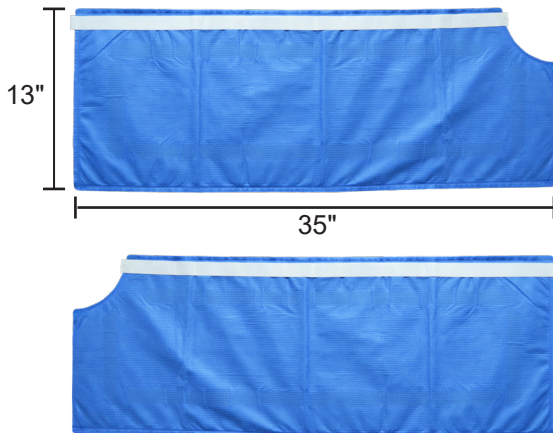

The Peripheral Flipper is a versatile radiation shield that adheres to the procedure drape during peripheral procedures for additional protection against scatter radiation. The device is designed with adhesive strips on the front and back, allowing users to place the shield in multiple locations for optimal protection. The Peripheral Flipper attenuates up to 83% of radiation at 90 kVp with a lead equivalence of 0.125mm.

- Lead-free & attenuates up to 83% at 90 kVp
- Adhesive strips on both sides help prevent slipping & allow the shield to be used in multiple locations
- Provides additional radiation protection during peripheral procedures
- Single-use & packaged sterile

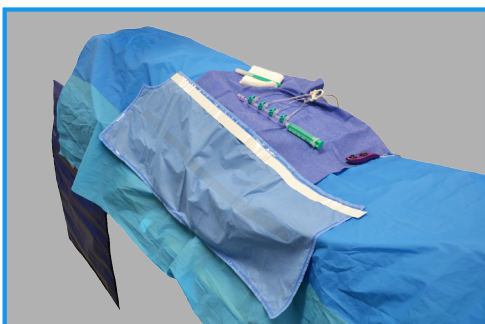

Item Number	Description	UOM
RAD-1030	Peripheral Flipper Radiation Protection Shield	Box of 5

RADIATION PROTECTION

HALO FLIPPER

RADIATION PROTECTION SHIELD

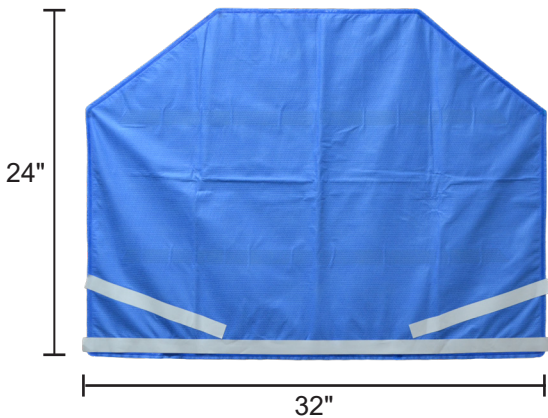

The Halo Flipper is a versatile radiation shield designed to conform and secure to the TZ Medical Comfort Halo to enable increased radiation protection at the head of the procedure table. The Halo Flipper attenuates up to 83% of radiation at 90 kVp with a lead equivalence of 0.125mm. The Halo Flipper is designed with adhesive strips on the back side of the shield and can also be used as an additional radiation protection drape when adhered to the edge of the procedure table.

- Lead-free & attenuates up to 83% at 90 kVp
- Provides additional radiation protection for staff members at the head of the procedure table
- Adhesive strips are designed to adhere securely around the flexible tubing of the Comfort Halo
- Can be used as an additional radiation protection table drape when adhered to the side of the procedure table
- Single-use & packaged sterile

Item Number	Description	UOM
RAD-1020	Halo Flipper Radiation Protection Shield	Box of 5

SR HEADBAND

RADIATION PROTECTION HEADBAND



The TZ Medical SR Headband is a cost-effective way to block scatter radiation from reaching one of the most sensitive areas of the body during diagnostic and interventional procedures. It is disposable, lead-free, easily worn, adjustable to any head size, and attenuates 87% of radiation at 80 kVp.

- Attenuates 87% of scatter radiation at 80 kVp
- Comfortable & lightweight
- Lead-free & disposable
- Fully adjustable, it can be worn over any style of cap
- Cost-effective way to increase safety in the lab



Item Number	Description	UOM
CZ-013	Radiation Protection Headband	Box of 10



NIKE BRAZEN

RADIATION PROTECTION EYEWEAR



The Nike Brazen features high-quality, distortion-free SF-6 Schott glass radiation-reducing lenses with 0.75mm Pb lead equivalency protection. These prescription radiation glasses are available in black and matte black/military blue.

NIKE PREMIER

RADIATION PROTECTION EYEWEAR



The Nike Premier features high-quality, distortion-free SF-6 Schott glass radiation-reducing lenses with 0.75mm Pb lead equivalency protection. These prescription radiation glasses are available in matte black, matte anthracite, and matte tortoise.

OAKLEY TURBINE

RADIATION PROTECTION EYEWEAR



The Oakley Turbine features a wrap-around, lightweight O-Matter frame that is comfortable for all-day use. The radiation-reducing lenses are made from distortion-free SF-6 Schott glass lenses and offer a protection level of .75mm Pb lead equivalency. These prescription Oakley radiation glasses are available in matte black and black ink.

OAKLEY HOLBROOK

RADIATION PROTECTION EYEWEAR



The Oakley Holbrook features high-quality, distortion-free SF-6 Schott glass radiation-reducing lenses with 0.75mm Pb lead equivalency protection. The Oakley Holbrook offers clear CE Certified lenses and weighs 74g. These prescription radiation glasses are available in matte black/red, matte black/silver, and black camo.

WILEY X P-17

RADIATION PROTECTION EYEWEAR



The Wiley X P-17 features high-quality, distortion-free SF-6 Schott glass radiation-reducing lenses with 0.75mm Pb lead equivalency protection. The Wiley X P-17 offers clear CE Certified lenses and weighs 71g. These prescription radiation glasses are available in gloss black, matte black, and brown tortoise.

For a full list of Radiation Protection Eyewear and Rx options, visit www.tzmedical.com

RADIATION PROTECTION

MOBILE BARRIERS



GLASS RADIATION PROTECTION BARRIERS

Our mobile radiation barriers provide solid, leaded X-ray protection with 2.0 mm lead equivalency. Each unit includes large, fully protective leaded glass windows for a clear line of sight, allowing you to work safely without compromising visibility or workflow.

Item Number	Description	UOM
TZ-LB-2430	Mobile Leaded Barrier, Leaded Window Size 24"H x 30"W, Overall Size 33"W x 75"H, 2.0mm Pb Eq	1 Each
TZ-LB-2436-S	Mobile Leaded Barrier, (Shorty), Leaded Window Size 24"H x 36"W, Overall Size 39.5"W x 62.5"H, 2.0mm Pb Eq	1 Each
TZ-LB-3048	Mobile Leaded Barrier, Leaded Window Size 30"W x 48"H, Overall Size 33"W x 75"H, 2.0mm Pb Eq	1 Each
TZ-LB-3060	Mobile Leaded Barrier, Leaded Window Size 30"W x 60"H, Overall Size 33"W x 75"H, 2.0mm Pb Eq	1 Each
TZ-LB-3648	Mobile Leaded Barrier, Leaded Window Size 48"W x 30"H, Overall Size 33"W x 75"H, 2.0mm Pb Eq	1 Each
TZ-LB-3672	Mobile Leaded Barrier, Leaded Window Size 36"H x 72"W, Overall Size 75"W x 75"H, 2.0mm Pb Eq	1 Each
TZ-LB-3036	Mobile Lead Barrier, Leaded Window Size 30"H x 36"W, Overall Size 33.5"W x 75"H, 2.0mm Pb Eq	1 Each
TZ-LB-2024-N	Mobile Lead Barrier Notched Style, Leaded Window Size 20"W x 24"W, Overall Size 27"W x 75"H, 2.0mm Pb Eq	1 Each
TZ-LB-1224	Mobile Leaded Barrier, Leaded Window Size 12"H x 24"W, Overall Size 52.5"W x 74"H	1 Each
TZ-LB-2436	Mobile Leaded Barrier, Leaded Window Size 24"H x 36"W, Overall Size 39.5"W x 75"H	1 Each
TZ-LB-2430-B	Tilted Mobile Leaded Barrier, Leaded Window 24"H x 30"W	1 Each

MOBILE SHIELDS

MOBILE RADIATION PROTECTION SHIELDS



Our lead protection shields offer flexible, easy-to-use solutions that help minimize radiation exposure during procedures. Simple in design but highly effective in performance, they allow you to maintain comfort and focus while working.

We also offer **porta shields** for versatile protection in imaging and interventional procedures. These lightweight, height-adjustable shields are easy to maneuver, making them ideal for fast-paced clinical environments where adaptability is key.

Item Number	Description	UOM
TZ-LB-MB2424	Mobile Lead Porta Shield, Royal Blue, 24"L x 24"W, .50mm Pb Eq	1 Each
TZ-LB-MB2436	Mobile Lead Porta Shield, Royal Blue, 24"L x 36"W, .50mm Pb Eq	1 Each
TZ-LB-MB2448	Mobile Lead Porta Shield, Royal Blue, 24"L x 48"W, .50mm Pb Eq	1 Each
TZ-2000404-PVC	PVC Heavy Duty Mobile Shield Barrier with 36"-58" Adjustable Height. Lead Shield Size 24"L x 24"W, .50mm Pb Eq	1 Each
TZ-MB-3024-TB	Deluxe Mobile Lead Shield on T-Base, 30"L x 24"W, .50mm Pb Eq	1 Each
TZ-MB-3024-TB-1	Deluxe Mobile Lead Shield on T-Base, 30"L x 24"W, 1.0mm Pb Eq	1 Each
TZ-LB-MB-3636	Max Mobile Lead Shield with H-Base, 36"L x 36"W, .50mm Pb Eq	1 Each
TZ-LB-MB-4848	Max Mobile Lead Shield with H-Base, 48"L x 48"W, .50mm Pb Eq	1 Each

SOFTGEL POSITIONERS

SOFTGELS



TZ-GELDA



TZ-GELDA-3



TZ-GELPD



TZ-GELND



TZ-GELHRS



TZ-GELPHR



TZ-GELSHP



TZ-GELHDP

HEAD GEL POSITIONER

The TZ Medical SoftGels provide superior cushioning and positioning, ensuring optimal exposure to the surgical site.

Item Number	Description	UOM
TZ-GELDA	Adult Gel Donut 8"OD x 3"ID x 1.75"H	1 Each
TZ-GELDA-3	Extra Deep Donut 8"OD x 3"ID x 3"H	1 Each
TZ-GELPD	Pediatric Donut 5.5"OD x 2.25"ID x 1.25"H	1 Each
TZ-GELND	Neonatal Donut 3.07"OD x 1.68"ID x 0.81"H	1 Each
TZ-GELHRS	Adult Horseshoe Donut 8"OD x 3"ID x 1.75"H	1 Each
TZ-GELPHR	Pediatric Horseshoe Donut 5.5"OD x 2.25"ID x 1.25"H	1 Each
TZ-GELSHP	Supine Headrest 11"OD x 9.5"ID x 2.625"H	1 Each
TZ-GELHDP	Head Pad 11"OD x 9.5"ID x 3.5"H	1 Each



SOFTGELS



TZ-GELPP10



TZ-GELCR4-20



TZ-GELPP14



TZ-GELCR6-12



TZ-GELPP18



TZ-GELCR6-16



TZ-GELCR4-12



TZ-GELCR6-20



TZ-GELCR4-16

BODY GEL POSITIONER

Item Number	Description	UOM
TZ-GELPP10	Gel Patient Positioner 10" x 4.5" x 2" (Sandbag Style)	1 Each
TZ-GELPP14	Gel Patient Positioner 14" x 4.5" x 2" (Sandbag Style)	1 Each
TZ-GELPP18	Gel Patient Positioner 18" x 4.5" x 2" (Sandbag Style)	1 Each
TZ-GELCR4-12	Flat Bottom Gel Chest Roll 12" x 4" x 4"	1 Each
TZ-GELCR4-16	Flat Bottom Gel Chest Roll 16" x 4" x 4"	1 Each
TZ-GELCR4-20	Flat Bottom Gel Chest Roll 20" x 4" x 4"	1 Each
TZ-GELCR6-12	Flat Bottom Gel Chest Roll 12" x 6" x 6"	1 Each
TZ-GELCR6-16	Flat Bottom Gel Chest Roll 16" x 6" x 6"	1 Each
TZ-GELCR6-20	Flat Bottom Gel Chest Roll 20" x 6" x 6"	1 Each



SOFTGEL POSITIONERS

SOFTGELS

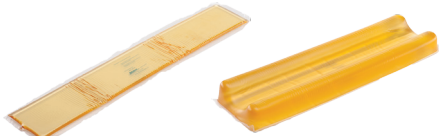

TZ-GELAF

TZ-GELAC



TZ-GELUPL

TZ-GELUPS



TZ-GELCC

TZ-GELHC



TZ-GELHP

TZ-GELAS

ARM GELS AND ANKLE/FOOT GELS

Item Number	Description	UOM
TZ-GELAF	Flat Armboard Gel 24" x 4.5" x 0.625"	1 Each
TZ-GELAC	Gel Contoured Armboard 20" x 5.75" x 2.25"	1 Each
TZ-GELUPL	Ulnar Nerve Protector, Large 20.13" x 13.75" x 0.25"	1 Each
TZ-GELUPS	Ulnar Nerve Protector, Small 16.25" x 6.5" x .5"	1 Each
TZ-GELCC	Gel Calf Cup	1 Each
TZ-GELHC	Gel Heel Cup	1 Each
TZ-GELHP	Heel Protector Pad	1 Each
TZ-GELAS	Ankle Stirrup Pad	1 Each



SOFTGELS

TABLE GELS



TZ-GELFT



TZ-GELFT3

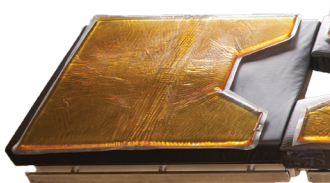

TZ-GELFT3-FT

Item Number	Description	UOM
TZ-GELFT	Full Length Table Gel Overlay 20" x 72" x 0.5"	1 Each
TZ-GELFT3-FT	Gel Foot Table Overlay 20" x 20" x 0.5"	1 Each
TZ-GELFT3-HD	Gel Head Table Overlay 20" x 10" x 0.5"	1 Each
TZ-GELFT3-T	Gel Torso Table Overlay 20" x 42" x 0.5"	1 Each
TZ-GELFT3	3 Piece Table Gel Overlay (Includes: TZ-GELFT3-FT, TZGELFT3-HD, TZ-GELFT3-T)	1 Each



PROCEDURE LIGHTING PRODUCTS

STARTROL



PROCEDURE ROOM LIGHTS

StarTrol LED Medical Lights produce a bright white light, (94 CRI and 4700K). They are ideal for true color rendition, and are cool and comfortable to work under, with virtually no radiant heat being generated by the LED's. The lights are energy-efficient, using less than one-third the energy of a halogen light, and require minimal maintenance. StarTrol LED Medical Lights are durable, precision machined in the USA and feature a 10-year warranty. TZ Medical offers a wide variety of light configurations, including ceiling-mounted, wall-mounted, and mobile rolling units, which are sure to fit into any workspace.

- Energy-efficient & eco-friendly
- Bright, natural white light
- 10-year limited warranty
- Cool to work under
- 40,000 hours of LED life
- Infinite variable positioning
- Multi-level dimming



Item Number	Description	UOM
ST-4X4-GSM	4 Light Spring Arm Mobile	1 Each
ST-8X4-GSM	8 Light Spring Arm Mobile	1 Each
ST-4X4-GSW	4 Light Spring Arm Wall	1 Each
ST-8X4-GSW	8 Light Spring Arm Wall	1 Each
ST-4X4-GS1	4 Light Spring Arm Single	1 Each
ST-8X4-GS1	8 Light Spring Arm Single	1 Each
ST-4X4-GS2	4 Light Spring Arm Dual	1 Each
ST-8X4-GS2	8 Light Spring Arm Dual	1 Each

TRUBRITE

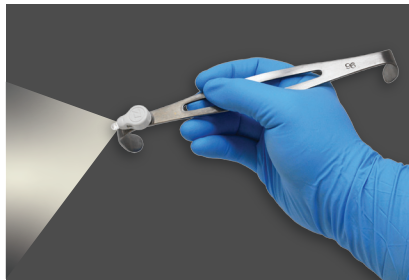

ADHESIVE RETRACTOR LIGHT

The TruBrite Adhesive Retractor Light is a sterile, single-use light source that maximizes visualization by directing focused light into surgical cavities, eliminating possible shadowing caused by overhead lighting systems. This low-profile device features a flexible LED light that can be adjusted to any desired position for optimal illumination. TruBrite provides over two (2) hours of continuous light output. The self-adhesive backing enables the TruBrite to be firmly mounted to multiple surgical instruments and surfaces.

- Sterile, compact & disposable design that weighs less than 4 grams
- Provides continuous light for over 2 hours
- Adjustable LED light, providing optimal visibility for any procedure
- Self-adhesive for effortless mounting on multiple surfaces
- Ideal for pacemaker pockets with Army-Navy retractors

Item Number	Description	UOM
ARL-1010	Adhesive Retractor Light	Box of 10

CARDIAC MONITORS

TRIDENT® PRO

HOLTER, EXTENDED HOLTER, MCT, AND EVENT



3-Electrode Cable & Charger



3-Electrode Cable with Charging Port & Barrel Jack Charger (Charge-While-Wear)



Trident™ Pro cardiac monitors combine decades of research and innovation to deliver a solution designed to streamline remote ECG recording from start to finish. Built-in telecom and a rechargeable lithium battery deliver the simplicity of a single-piece device with options for remote or local configuration and data transmission.



Records up to 30 days of continuous EKG data



Large LCD color touchscreen with an on-board digital diary



Lithium battery may be charged while in use



Compact and discrete device with water-resistant case

Trident™ Pro monitors are equipped with a large LCD touchscreen and on-board patient diary that provide a user-friendly experience for manually recorded patient events. Three channels of ECG data are acquired from surface electrodes adhered to the body, and 8G of internal memory with an advanced detection algorithm offer a versatile solution to capture, store, and transmit every beat for up to 30 days.

MONITOR	ITEM #	DESCRIPTION
Trident™ 40	H3R-0039	Digital Holter Monitor for Holter and Extended Holter Studies Only
Trident™ 40L	H3R-0130	4-in-1 Device - Holter, Extended Holter, MCT, and Event Monitor

Accessories



USB Data Cable



Belt Clip Holster



TRIDENT® NANO

HOLTER MONITOR

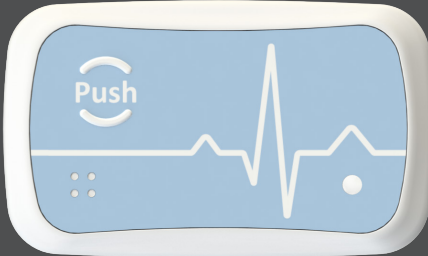

Multiple Wear Options

Adult Patch
Electrode HPR-0132





Pediatric Patch
Electrode HPR-0150

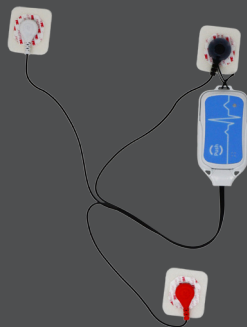

3-Electrode Lead-Clip Cable
HPR-0130



The Trident™ Nano is an accurate, reliable, water-resistant, and fully rechargeable monitor designed to capture clear and comprehensive ECG tracings during Holter and Extended Holter studies. Three channels are recorded from either a long-wear patch electrode or patient cable, and its slim, unobtrusive design optimizes patient comfort and compliance.

-  Records 3 channels of ECG from a single patch electrode
-  Fast and simple data retrieval via USB connection
-  Fully reusable and rechargeable device
-  3-color LED light indicator for device notifications
-  Water-resistant for showering

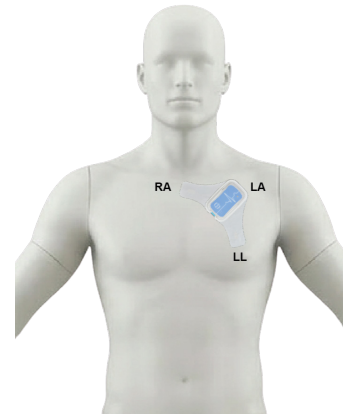

With multiple wear options, 8G of internal storage, and a low-profile design, the Trident™ Nano offers a unique combination of minimal body burden with consistently clear ECG tracings and the superior diagnostic yield of a 3-channel recording for study durations up to 15 days.

MONITOR	ITEM #	DESCRIPTION
Trident® 30	HPR-0014	Digital Cardiac Monitor for Holter and Extended Holter Studies, Used with Adult Patch, Pediatric Patch, and Lead-Clip Cable

Accessories

Single-Bay Charging Dock

Single-Bay USB Dock

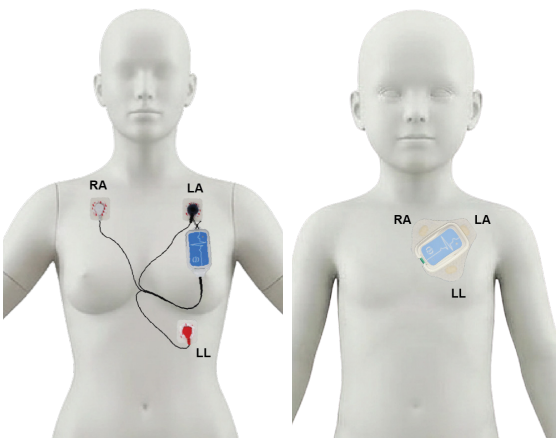

Comprehensive Cardiac Monitoring



Clear Signals. Confident Decisions.

Ambulatory ECG monitoring should provide clear diagnostic information without unnecessary complexity.

TZ Medical Monitoring Solutions delivers reliable data, certified analysis, and timely reporting designed to support confident clinical decisions.

**Patient
Enrollment**

**Continuous
Monitoring**



What Fully Managed Monitoring Includes

Everything your team needs, from start to report, is handled by TZ Medical.



**Device fulfillment
and patient
onboarding**



**Patient and
technical
support**



**Certified cardiac
technician
analysis**



**Physician-ready
diagnostic
reports**



**Ongoing
account
support**

Without the Operational Burden

Find Information Relevant to Your Role



Physicians

Clinical confidence through multi-channel monitoring



Administrators

Predictable performance.
Scalable workflows.



Clinical Staff

Monitoring designed to reduce daily workload



Patients

A monitoring experience patients can understand



100% Human Review

24-48 Hour Report Turnaround

Clinical Oversight & Quality Assurance

TZ Medical monitoring services are supported by certified cardiac technicians and structured clinical review processes designed to ensure accuracy, consistency, and reliable diagnostic reporting. We follow established analysis protocols and maintain rigorous quality standards to support confident clinical decision-making.

Let's Simplify Cardiac Monitoring

Discuss monitoring workflows, alert configuration, and clinical integration with our monitoring specialists.

TZ Medical Monitoring Solutions

800-338-1109

support@tzmonitoringsolutions.com

tzmonitoringsolutions.com



TZ Medical

Sparked by your ideas

**Clinician-Driven Devices Designed for
Real Clinical Workflows**



800.944.0187



tzmedical.com



info@tzmedical.com



The Joint Commission
National Quality Approval



PROUD SUPPORTER

